



ASCLASS

ASCLASS CERRAHİ ALETLER İMALAT SAN. VE TİC. LTD.ŞTİ

📍 Çatalarmut Mahallesi Sezgin Sokak No:7 Kat:1/2/3 İlkadım/SAMSUN

📱 asclasscerrahialetler.ve.medya 🌐 Asclass cerrahi aletler 🌐 www.asclassgrup.com 📧 info@asclassgrup.com - asclassmedya@gmail.com

ÜRÜN GRUPLARIMIZ

- » Genel Cerrahi
- » Beyin Cerrahi
- » Ortopedi Cerrahi
- » Göz Cerrahi
- » Kulak Burun Boğaz
- » Jinekoloji
- » Üroloji
- » Kalp Damar
- » Üniversal Ekartör Setleri
- » Laparoskopik Ekartör Setleri
- » Laparoskopik El Aletleri
- » Steril Konteynir Sistem

47-



Ø 2.0 mm



47-100 13 cm
47-101 14.5cm
47-102 16 cm
47-103 18 cm
47-104 20 cm
Mirtle yaprak sondalar
Myrtle leaf probes

Ø 1.5 mm



$\frac{1}{2}$
47-105
Mirtle yaprak sonda
Myrtle leaf probe
14.5 cm



47-106 Ø 2.5 mm
14.5 cm
47-107 Ø 2.5 mm
16 cm
47-108 Ø 3.0 mm
20 cm
Delikli sondalar
Probes with eye



47-109 - 47-129
Sondalar/Probes

Uc çapı Diameter of tip			Uzunluk Lenght
1 mm	1.5 mm	2 mm	
47-109	47-116	47-123	13 cm
47-110	47-117	47-124	14.5 cm
47-111	47-118	47-125	16 cm
47-112	47-119	47-126	18 cm
47-113	47-120	47-127	20 cm
47-114	47-121	47-128	25 cm
47-115	47-122	47-129	30 cm

Ø 3.5 mm



47-133 25 cm
47-134 30 cm
Çift başlı sondalar
bükülebilir, delikli
Double ended probes,
malleable, with hole

Ø 4 mm



47-135
Çift başlı sonda
bükülebilir
Double ended probe,
malleable
40 cm

Ø 2.0 mm



47-136
Sonda/Probe
30 cm

$\frac{1}{2}$
47-130
12.5 cm

$\frac{1}{2}$
47-131
Sinus sonda
Sinus probe
15 cm

$\frac{1}{2}$
47-132
Çift başlı sonda
bükülebilir, delikli
Double ended probe,
malleable, with hole
19 cm



47-137 Ø 07. + 0.8 mm
47-138 Ø 0.9 + 1.1 mm
47-139 Ø 1.3 + 1.4 mm
47-140 Ø 1.5 + 1.6 mm
47-141 Ø 1.8 + 1.9 mm
Sondalar/Probes
13 cm
Gümüş/Silver
BOWMAN

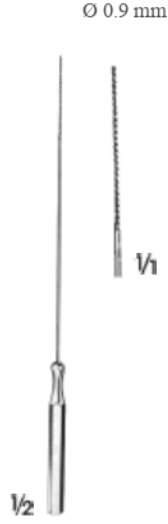

BUCK
47-142
Pamuk aplikatör
Cotton applicator
Ucu sert burgulu
Rough, spiral end
12 cm



47-143
Sonda/Probe
16 cm



SEIFFERT
47-144
Sonda/Probe
Gümüş/Silver
19.5 cm

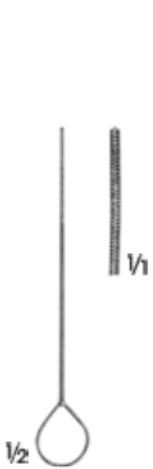

KINGS'S COLLEGE
HOSPITAL 47-145
Pamuk aplikatör
Cotton applicator
Sert burgulu
Rough, spiral end
9 cm



STACKE
47-146
Sonda/Probe
Gümüş/Silver
10 cm



KINGS'S COLLEGE HOSPITAL
47-147
Pamuk aplikatör
Cotton applicator
Sert burgulu
Rough, spiral end
13.5 cm



CAWTHORNE
47-148
Sonda/Probe
Yaprak uçlu, gümüş
Flattened end silver
14 cm





FARRELL
47-149
Ucu yuvarlak tırtıllı
Round serrated end
14 cm



LATHBURY-FARRELL
47-150
Ucu üçgen tırtıllı
Triangular serrated end
14 cm



LATHBURY-FARRELL
47-151
Ucu üçgen tırtıllı
Triangular serrated end
14 cm



47-152
Ucu sert burgulu
Rough, spiral end
14 cm



47-153
Ucu sert burgulu
Rough, spiral end
14 cm



47-154
Ucu sert burgulu
Rough, spiral end
18 cm



FARRELL
47-155
Ucu sert burgulu
Rough, spiral end
16 cm

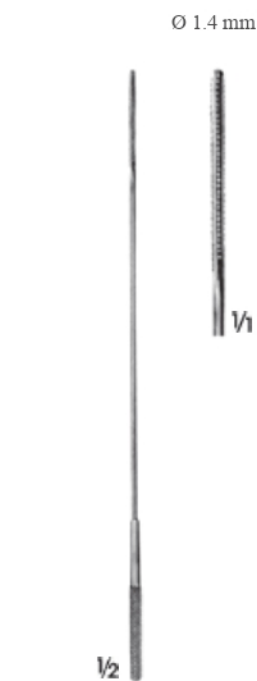

LATHBURY-FARRELL
47-156
Ucu üçgen tırtıl
Triangular serrated end
16 cm



LATHBURY-FARRELL
47-157
Ucu üçgen tırtıl
Triangular serrated end
16 cm

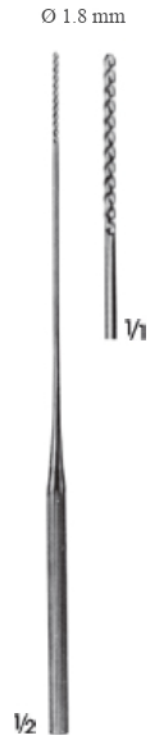

47-158
Ucu sert burgulu
Rough, spiral end
18 cm

Ø 3.5 mm



47-159 13 cm
47-160 14.5 cm
47-161 16 cm
İçi kanallı sondalar
Directors



DOYEN
47-162
İçi kanallı sonda
Director
14.5 cm



NELATON
47-163
İçi kanallı sonda
Director
16 cm



47-164
İçi klavuzlu sonda
Director with tip
14 cm

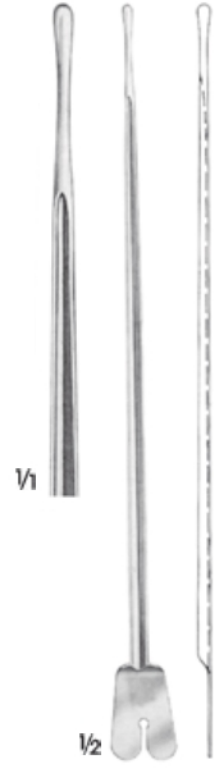

BRODIE
47-165
İçi klavuzlu sonda
Director with tip
20 cm

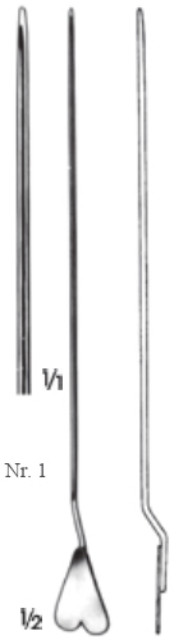

Nr. 1

LOCKHART-MUMMERY
47-166 Nr. 1 Düz/Straight
47-167 Nr. 2 45° Eğri/Curved
47-168 Nr. 3 90° Eğri/Curved
47-169 Nr. 4 Eğri/Curved
Fistül sondalar/Fistula probes
16.5 cm

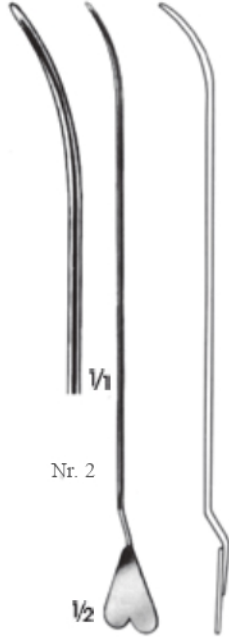

Nr. 2

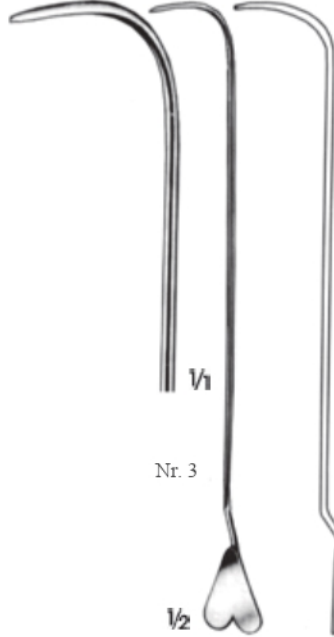

Nr. 3

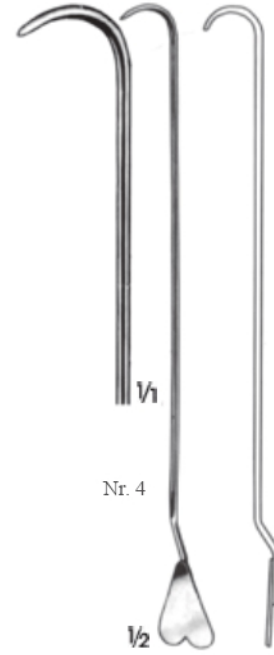

Nr. 4



47-170
İçi kanallı tel klavuzlu
sonda, bükülebilir
Director with wire
loop, malleable
19 cm



47-171
Spatula/Spatula
14.5 cm



16 mm
47-172
Spatula/Spatula
14.5 cm

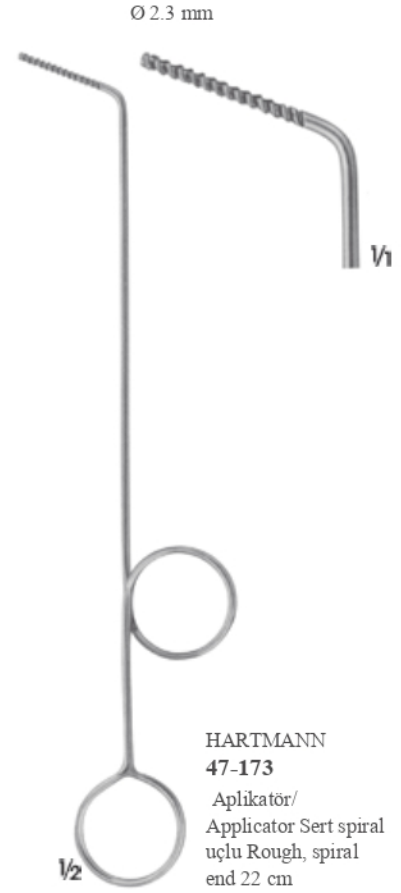

HARTMANN
47-173
Aplikatör/
Applicator Sert spiral
uçlu Rough, spiral
end 22 cm



PICCOLO
47-174
Aplikatör/Applicator
Ucu yuvarlak tırtıllı
Round serrated end
11 cm



PICCOLO
47-175 Aplikatör/
Applicator
Ucu üçgen tırtıllı
Triangular serrated end
11 cm



FARRELL
47-176 Aplikatör/
Applicator
Ucu yuvarlak tırtıllı
Round serrated end
11 cm



LATHBURY-FARRELL
47-177
Aplikatör/Applicator
Ucu üçgen tırtıllı
Triangular serrated end
11 cm



ZOELLNER

- 47-178 Ø 26 swg, Ø 0.4 mm
 - 47-179 Ø 24 swg, Ø 0.5 mm
 - 47-180 Ø 22 swg, Ø 0.7 mm
 - 47-181 Ø 20 swg, Ø 1.0 mm
 - 47-182 Ø 18 swg, Ø 1.2 mm
- 10'luk paket/Package of 10 pieces

1/1



VERHOEVEN

- 47-183 Ø 24 swg, Ø 0.5 mm
 - 47-184 Ø 22 swg, Ø 0.7 mm
 - 47-185 Ø 20 swg, Ø 1.0 mm
 - 47-186 Ø 18 swg, Ø 1.2 mm
 - 47-187 Ø 16 swg, Ø 1.5 mm
- Aspiratör ucu, LUER koniği
Suction cannulae with Luer cone
10 cm

1/2

Olive
Ø 7 mm



1/1

HOUSE
47-188

Parmak kumandalı emiş adaptörü LUER koniği, LUER bağlantılı
Suction adapter with finger cut-off, LUER cone, LUER hub
5.5 cm



- 47-189 Ø 1.5 mm
- 47-190 Ø 2.0 mm
- 47-191 Ø 2.5 mm
- 47-192 Ø 3.0 mm

PLESTER

Parmak kumandalı, temizleme telli parmak basma yüzeyi baş parmağa paralel LUER bağlantı
With finger cut-off and stylet, thumb piece parallel to curve, with LUER hub
19.5 cm

Olive
Ø 6-9 mm

1/2

Ø 3 mm



Olive
Ø 8 mm

1/2

ADSON
47-193

Aspiratör ucu
Suction cannula
Parmak kumandalı ve temizleme telli
With finger cut-off and stylet
16.5 cm

Ø 4 mm

Olive
Ø 9 mm



1/2

ADSON
47-194

Parmak kumandalı
With finger cut-off
19 cm





FERGUSSON

Çalışma boyu Working length	11 cm	13 cm	16 cm	20 cm	
Tam boy Total Length	18 cm	21.5 cm	24.5 cm	28 cm	Ø
	47-195	47-201	47-207	47-213	1.5 mm
	47-196	47-202	47-208	47-214	2.0 mm
	47-197	47-203	47-209	47-215	2.5 mm
	47-198	47-204	47-210	47-216	3.0 mm
	47-199	47-205	47-211	47-217	4.0 mm
	47-200	47-206	47-212	47-218	5.0 mm

Parmak kumandalı, temizleme telli
parmak basma yüzeyi yatay LUER bağlantı
With finger cut-of and styled
Thumb piece 90° to curve, With LUER hub

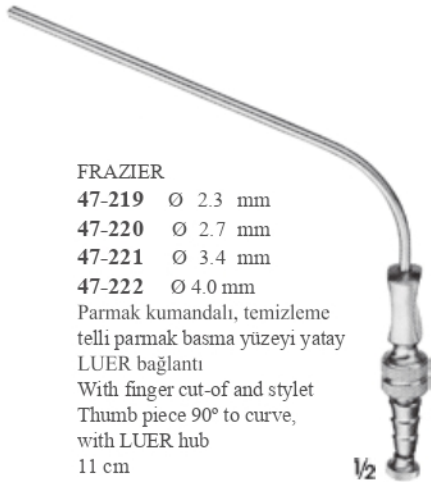

Olive
Ø 6-9 mm

FERGUSSON

47-223 Ø 4 mm
İzoleli, parmak kumandalı, temizleme telli
parmak basma yüzeyi yatay LUER bağlantı
Insulated, with finger cut-of and stylet,
thumb piece 90° to curve, with LUER hub
18 cm

1/2

Olive
Ø 6-9 mm

FRAZIER

47-224 Ø 3 mm
47-225 Ø 5 mm
Parmak kumandalı, temizleme telli
parmak basma yüzeyi yatay LUER bağlantı
With
Thumb piece 90° to curve, with LUER hub
18 cm

1/2



Olive
Ø 9 mm
FORMBY
47-226 Ø 3.3 mm
21 cm



Olive
Ø 6-9 mm
GILLIES
47-227 Ø 3 mm
Parmak kumandalı ve
temizleme telli
With finger cut-off and stylet
17 cm



Olive
Ø 7-9 mm
LEMPERT
47-228 Ø 2 mm
47-229 Ø 3 mm
Parmak kumandalı ve
temizleme telli
With finger cut-off and stylet
20 cm



Olive
Ø 6-8 mm
WULLSTEIN
47-229 Ø 0.4 mm
47-230 Ø 0.6 mm
47-231 Ø 0.8 mm

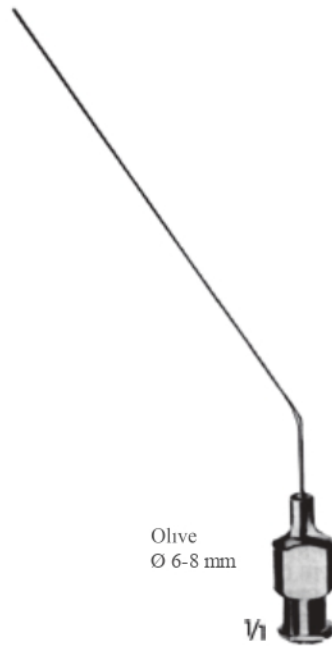

Olive
Ø 6-8 mm



47-232 Komple/Complete
47-233 Sap/Handle
47-234 Ø 0.5 mm
47-235 Ø 0.7 mm
47-236 Ø 1.0 mm
47-237 Ø 1.3 mm
LUER koniği/With LUER cone





WULLSTEIN
47-238
Aspiratör ucu
konik şeklinde gümüş
Suction tube
conical, silver
LUER bağlantılı
With LUER hub
16 cm



WULLSTEIN
47-239 Ø 1.5 mm
47-240 Ø 2.0 mm
Gümüş/Silver
LUER bağlantılı
With LUER hub
16 cm



SCHUKNECHT
47-241 Ø 1 mm
47-242 Ø 0.5 mm
Aspiratör ucu Suction
cannulae 13 cm



BARRON
47-243 Ø 1.3 mm
47-244 Ø 2 mm
Parmak kumandalı ve
temizleme telli
With finger cut-off and stylet
16 cm

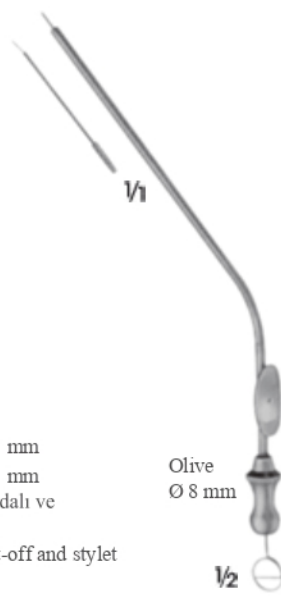

BELLUCCI
47-245 Komple/Complete
47-246 Parmak kumandalı ve
temizleme telli
With finger cut-off and stylet
47-247 Ø 0.5 mm
47-248 Ø 0.7 mm
47-249 Ø 1.0 mm
15.5 cm



ZOELLNER
47-250

47-251

Uc genişliği 6.5 mm
Tip wide 6.5 mm
Burun aspiratör ucu, LUER bağlantılı
Nasal suction tube, with LUER hub
18 cm



GORNEY

47-252

Aspiratör disektör
Suction dissector
18 cm



NEGUS

47-253

Aspiratör disektör
Suction dissector
21 cm



YASARGIL

47-254

Kanül/Cannulae
LUER-LOC koniği
LUER-LOC cone
20 cm



LOPEZ-REINKE

47-255

Aspirasyonlu Tonsil disektör
Tonsil dissector with suction
device
23.5 cm



LANDOLT

47-256 Genişlik/Wide 3.2 mm
Hipofizektomi ve Kbb için aspiratör ucu,
keskin açılı nokta
Dissecting suction tube for hypophysectomie
and ENT, sharp agled point
20 cm



47-257 4 mm
47-258 5 mm
Aspiratör raspa, sivri bayonet tip
Suction raspatories, sharp
bayonet-shaped
20 cm



HOUSE

47-259 Ø 0.9 - 0.7 mm
47-260 Ø 1.2 - 0.9 mm
47-261 Ø 1.5 - 1.2 mm
Parmak kumandalı ve temizleme telli
With finger cut-off and stylet

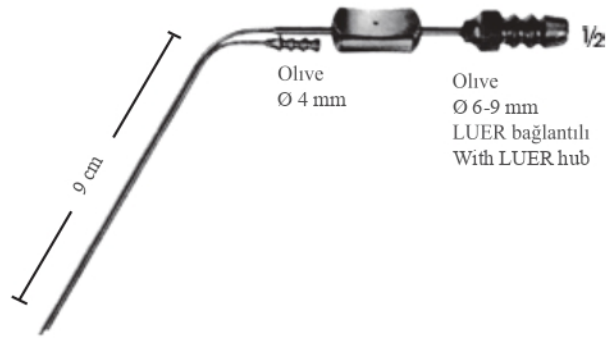

47-262 Ø 2.0 mm
47-263 Ø 2.5 mm
47-264 Ø 3.0 mm
Parmak kumandalı ve temizleme telli
parmak basma yüzeyi yatay
With finger cut-off, thumb piece 90° to curve
25 cm



47-265
Parmak kumandalı ve
temizleme telli
With finger cut-off and stylet

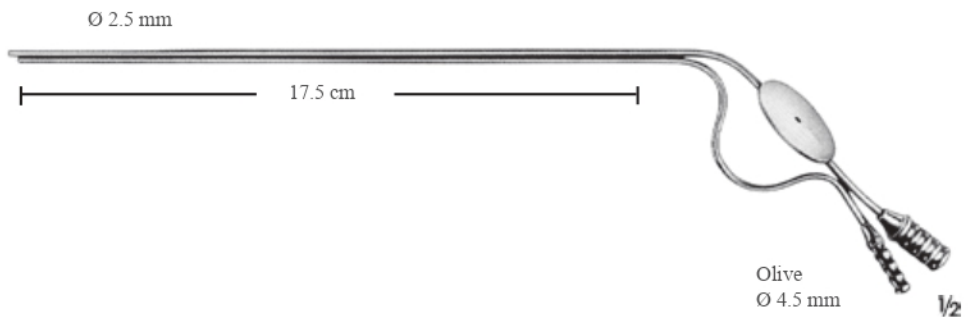

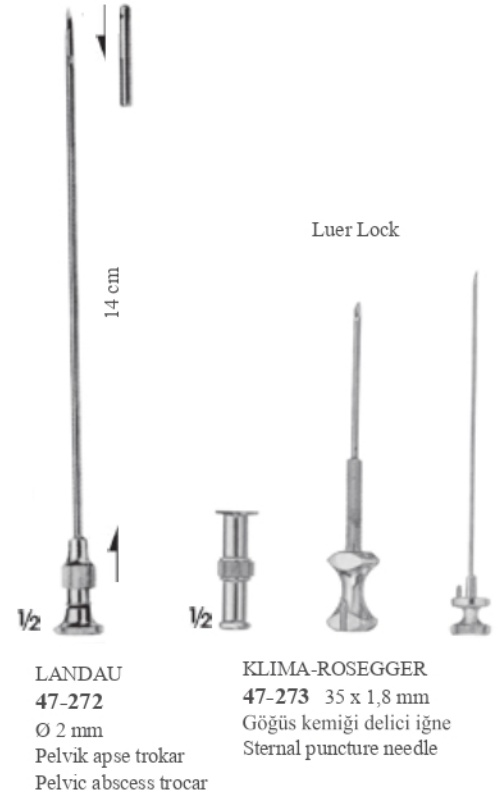

POOL

47-277

Aspiratör kanülü, vidalanabilir dış tüpü ile
Suction cannula, with outer tube to be
screwed off
22.5 cm

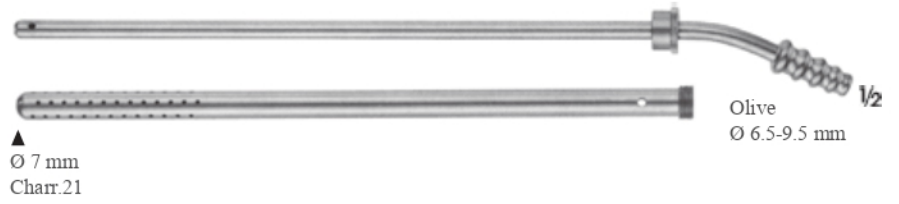

47-278

Büyük miktarda sıvı temizlemek için
For clearing large quantities of fluid
19 cm

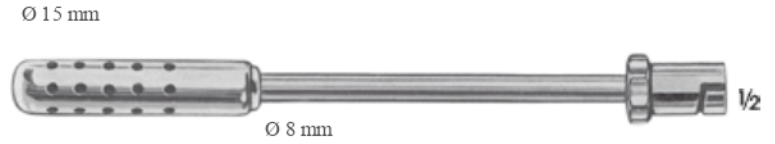

POOL

47-279

Aspiratör kanülü, vidalanabilir dış tüpü ile
Suction cannula, with outer tube to be
screwed off
22.5 cm



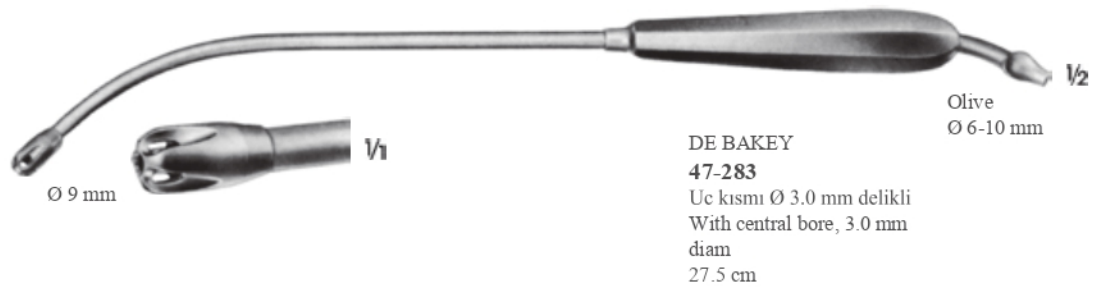
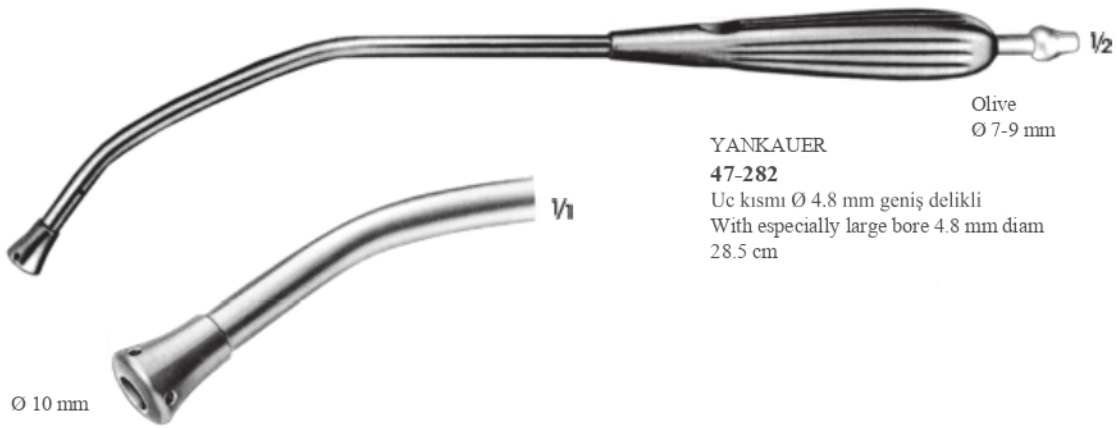



MAGILL
47-285 Ø 3.0 mm
47-286 Ø 3.5 mm
47-287 Ø 4.0 mm
 Magil emiş kanülü
 Stylet for magill suction tubes
 24.5 cm



ROWBOTHAM
47-288
 Kanül/
 Cannulae 29.5
 cm

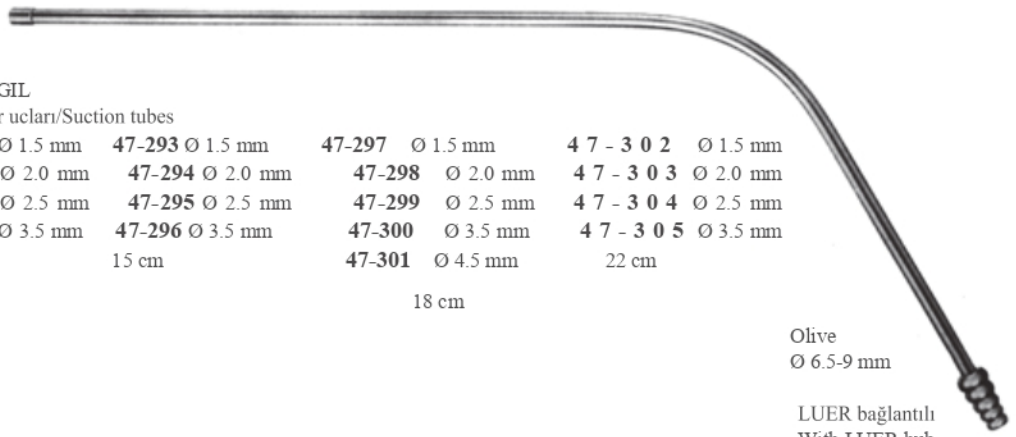

YASARGIL

Aspiratör uçları/Suction tubes

47-289 Ø 1.5 mm	47-293 Ø 1.5 mm	47-297 Ø 1.5 mm	47-302 Ø 1.5 mm
47-290 Ø 2.0 mm	47-294 Ø 2.0 mm	47-298 Ø 2.0 mm	47-303 Ø 2.0 mm
47-291 Ø 2.5 mm	47-295 Ø 2.5 mm	47-299 Ø 2.5 mm	47-304 Ø 2.5 mm
47-292 Ø 3.5 mm	47-296 Ø 3.5 mm	47-300 Ø 3.5 mm	47-305 Ø 3.5 mm
13 cm	15 cm	47-301 Ø 4.5 mm	22 cm
		18 cm	

Olive
 Ø 6.5-9 mm

LUER bağlantılı
 With LUER hub

Ø 3,5 mm

Ø 2,0 mm

47-306 50 cm
47-307 35 cm
 Aspiratör uçları/Suction tubes
 Lastik ucu
 With rubber tip

Olive
 Ø 6-9 mm

LUER bağlantılı
 With LUER hub



Ø 15 mm

FINSTERER
47-308
Sulama kanülü
Irrigation cannula
32 cm

Olive
Ø 9 -13 mm

1/2

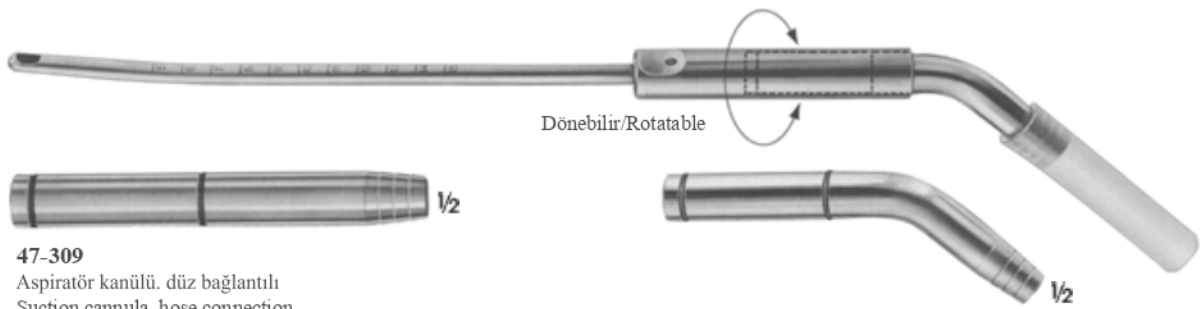

Dönebilir/Rotatable

47-309

Aspiratör kanülü, düz bağlantılı
Suction cannula, hose connection
straight
Ø 11 mm

47-310

Aspiratör kanülü, eğri bağlantılı
Suction cannula, hose connection,
curved
Ø 11 mm

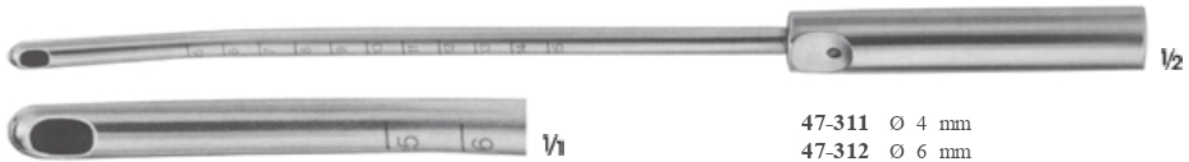

47-311 Ø 4 mm
47-312 Ø 6 mm
47-313 Ø 8 mm
47-314 Ø 10 mm
47-315 Ø 12 mm
47-316 Ø 14 mm

Vakum küreti, vakumlu kürtaj
için emme kanülü
Currettes with graduation and suction
interrupter, for vaccum curettage

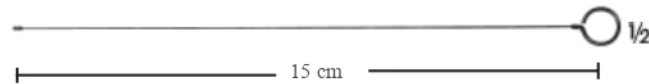

15 cm

Vakum hortumu için bağlantı
Connection for suction hose



LANDOLT

47-317 İzoleli/Insulated

Pıhtı emiş kanülü, mandrenli ve stoplu Ø 5 mm
143 ° buhar sterilizatörlerinde steril edilebilir.

Coagulation suction cannula
with interrupter and mandrel Ø 5 mm

Can be sterilized in a steam sterilizer up to 143 °

Çap/Olive
Ø 7.5-12 mm

HF elektrotları tarafından dokunulmuş,
lekelenmemiş bağlantı Ø 4 mm
HF-Elektrot kolu Ø 4 mm
Untarnished contact to be
touched by HF-electrodes Ø 4 mm



ASCLASS

ASCLASS CERRAHİ ALETLER İMALAT SAN. VE TİC. LTD.ŞTİ

 [asclasscerrahialetler.ve.medya](https://www.instagram.com/asclasscerrahialetler.ve.medya)  [Asclass cerrahi aletler](https://www.facebook.com/Asclass.cerrahi.aletler)  www.asclassgrup.com  info@asclassgrup.com - asclassmedya@gmail.com

 Çatalarmut Mahallesi Sezgin Sokak No:7 Kat:1/2/3 İlkadım/SAMSUN